



LED Canopy Heavy Duty



Description

The LITELUME™ LED Canopy Heavy Duty (LL-CHD) is a premium performance luminaire delivering up to 133 lumens per watt. Featuring a sealed IP65 rated heavy duty die-cast housing and shatter-resistant polycarbonate acrylic optical lens with UV stabilizers. Compact in design and symmetry making this luminaire ideal for industrial, commercial, storage, walkways, parking garages, entrance ways, and high illumination canopy applications.

Fixture Information

Size:	100W
Housing:	Die-cast Housing
Finish:	Protective powdercoat
Color:	Standard: White
Lens:	Polycarbonate
CRI:	80
Power Factor:	.90
Surge Protector:	Optional: 10 kVA
Voltage:	Standard: 120-277V
Operating Temperature:	-4°F to 131°F
Sensor:	Standard: No sensor Optional: Field Installed Motion Sensor
Warranty:	5-Year Limited Warranty

Performance Data

Lumen Output:

12,600 to 13,300 lm

Lumens Per Watt (typical):

126 to 133 lm/W

CCT:

4000K
5000K
5700K

Distribution

160°

Lifespan:

Features high performance LED's with up to 100,000 running hours

Ratings & Certificates

UL Listed For Wet Location
IP66 rated



QuickShip Ordering Information

Part #

LL-CHD-100-50-UNV-WH



Dimension

Item	Length	Height	Width
100W	10.04"	4.92"	10.04"

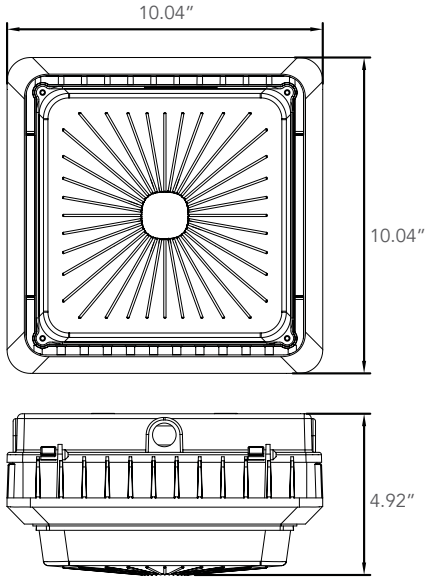

Photometrics

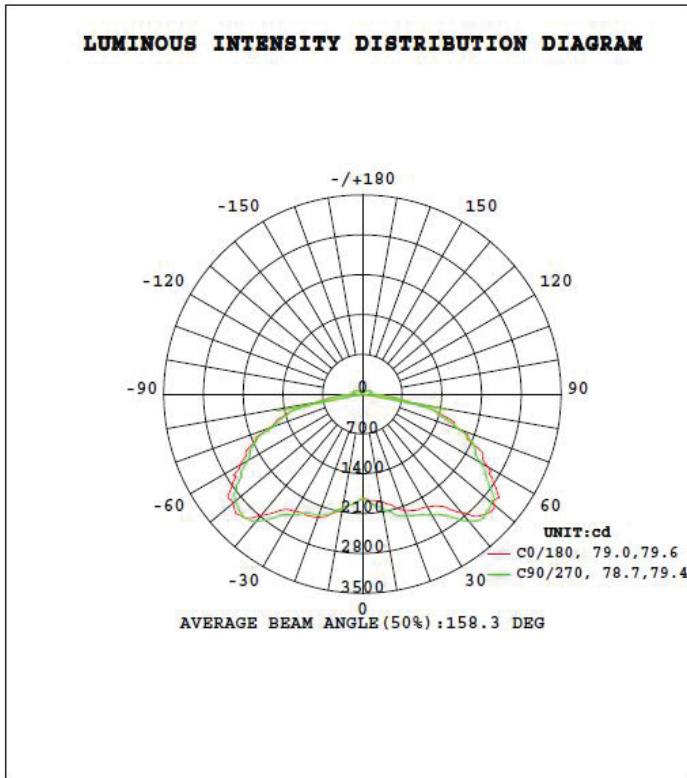



Project Name	
Catalog #	
Job Type	
Prepared By	
Notes	

Fixture Ordering Information

Part #	Wattage	Lumens	Kelvin	Voltage	Distribution
LL-CHD-100-57-UNV-WH	100	13300	5700	120-277	160
LL-CHD-100-50-UNV-WH	100	13000	5000	120-277	160
LL-CHD-100-40-UNV-WH	100	12600	4000	120-277	160

* Not all product variations listed on this page are DLC qualified. Visit www.designlights.org/search to confirm qualification

QuickShip Ordering Information

Part #
LL-CHD-100-50-UNV-WH

Accessory Ordering Information

Part #	Description
FIMS	Field Installed Motion Sensor
SP10-277	Surge Protection 10 kVA 277V

* Please contact LITELUME for all Custom Option Requests