



# Garage Canopy Equalizer



## Description

The LITELUME™ LED Garage Canopy Equalizer (LL-GCE) is a low profile luminaire constructed with a IP65 rated one piece die cast housing suitable for both indoor and outdoor applications. Subtle equal illumination with 15% uplight to provide enhance uniformity. Featuring a proprietary optical system with anti-glare lens making this fixture ideal for parking garages, storage areas, walkways and low or high security areas.

## Fixture Information

Size:	45W/70W
Housing:	High performance Die-cast Aluminum
Finish:	Protective powder coat
Colors:	Standard: White (WH) Bronze (BZ)
Mountings:	Surface Mount or Pendant
Lens:	Polycarbonate
Uplight:	15%
CRI:	80
Power Factor:	.90
Dimmable:	Standard: 0-10v continuous
Voltage	120-277V
Operating Temperature:	-22F - 113F
Sensor:	Standard: No sensor Optional: Microwave Motion Sensor
Warranty:	10-Year Limited Warranty

## Performance Data

### Lumen Output:

5,625 to 8,750 lm

### Lumens Per Watt (typical):

125 lm/W

### CCT:

4000K

5000K

### CCT:

Type V

### Lifespan:

Features High performance LED's with up to 100,000 running hours

### Ratings & Certificates

UL Listed For Wet Location

IP65 rated

Title 24 Compliant





## Dimension

Item	Width	Width	Height	Weight
GCE	13.8"	13.8"	2.6"	9.32"

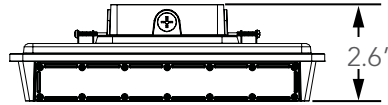
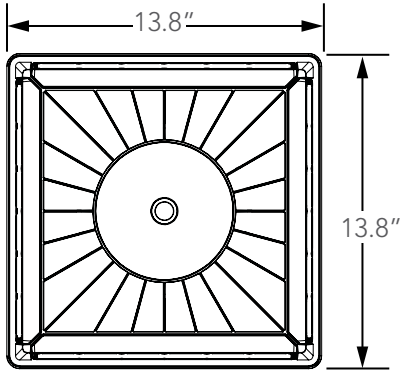

## Photometric Data

### 45W 4000K

LUMINOUS INTENSITY DISTRIBUTION DIAGRAM

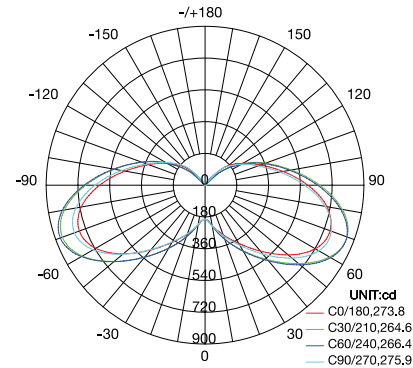

AVERAGE BEAM ANGLE(50%):270.2 DEG

C0 PLANE ISOLUX DIAGRAM (UNIT:lx)

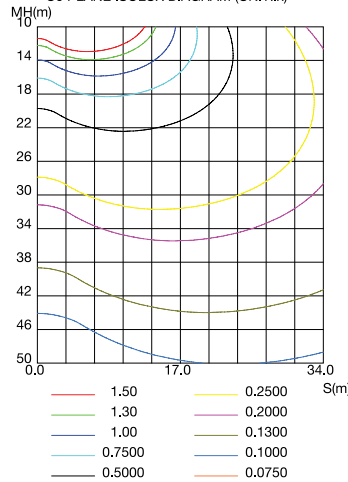

ISOLUX DIAGRAM

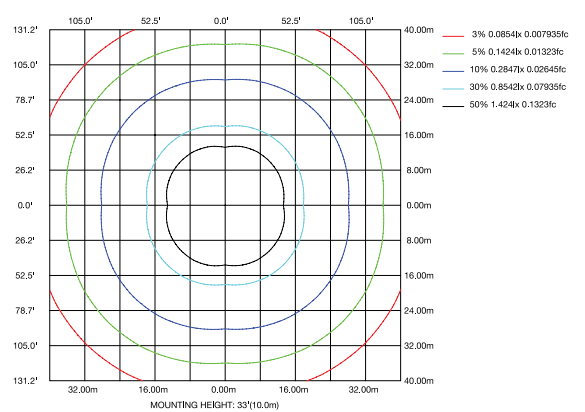

### 75W 5000K

LUMINOUS INTENSITY DISTRIBUTION DIAGRAM

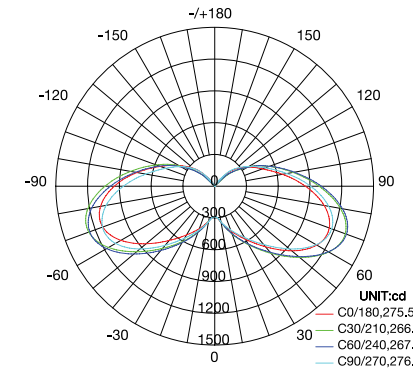

AVERAGE BEAM ANGLE(50%):271.4 DEG

C0 PLANE ISOLUX DIAGRAM (UNIT:lx)

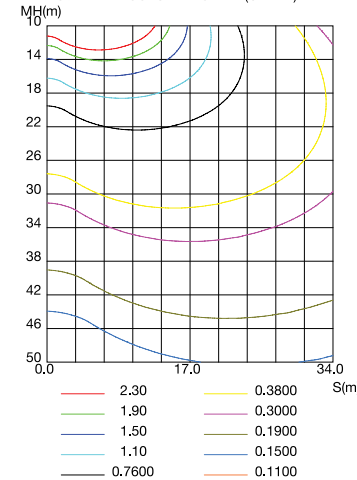

ISOLUX DIAGRAM

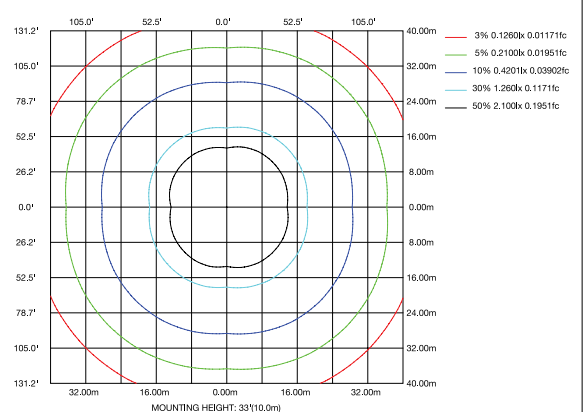



<b>Project Name</b>	
<b>Catalog #</b>	
<b>Job Type</b>	
<b>Prepared By</b>	
<b>Notes</b>	

### Fixture Ordering Information

Part #	Wattage	Lumens	Kelvin	Voltage
LL-GCE-45-50-UNV-WH	45	5625	5000	120-277
LL-GCE-45-40-UNV-WH	45	5625	4000	120-277
LL-GCE-70-50-UNV-WH	70	8750	5000	120-277
LL-GCE-70-40-UNV-WH	70	8750	4000	120-277
LL-GCE-45-50-UNV-BZ	45	5625	5000	120-277
LL-GCE-45-40-UNV-BZ	45	5625	4000	120-277
LL-GCE-70-50-UNV-BZ	70	8750	5000	120-277
LL-GCE-70-40-UNV-BZ	70	8750	4000	120-277

### Accessories Ordering Information

Part #	Description
BRI823-B-D	Sharkward 120-277V 0-10V PIR Sensor
RC-100	Remote Control 100
BRI823-B-D-BLE-GE	HOMEWELL GEBC 12-24V DC 0-10V 120-277V Bluetooth PIR Sensor
EM8	Emergency Battery Back Up 8W
EM15	Emergency Battery Back Up 15W

\* Please contact LITELUME for all Custom Option Requests