

Bollard Luminaire 360 Installation Instructions



⚠ Warning

PLEASE READ ALL INSTRUCTIONS BEFORE ATTEMPTING INSTALLATION

1. To prevent personal injury or product damage, only licensed electricians should install.
2. To avoid electrical shock or component damage, disconnect power before attempting installation or servicing.
3. This product must be installed in accordance with the national electrical code (NEC) and all applicable federal, state and local electrical codes and safety standards.
4. Disconnect product and allow cooling prior to servicing.
5. Any alteration or modification of this product is expressly forbidden as it may cause serious personal injury, death, property damage and/or product malfunction.
6. To prevent product malfunction and/or electrical shock, this product must be properly grounded.
7. This luminaire is designed to operate in ambient temperatures ranging from -40°C to 45°C and to be horizontally mounted with the LEDs facing down.
8. This product must be installed in accordance with the applicable installation code by a person familiar with the construction and operation of the product and the hazards involved.
9. Min 75°C supply conductors.
10. This product is not available for several special environments, such as places with corrosive gas liquids or high pressure water vapor.
11. The allowable ambient temperature is 10°C to 40°C when configuring the emergency battery kit.

Instructions

1. Verify bolt circle diameter and anchor bolt projection and use anchor bolt template to assure accuracy.
2. Place the bollard over base Anchor Bolts.
3. Loosely tighten the washers and nuts provided. Tighten all nuts and screws.
4. Be sure supply leads extend far enough to make fixture connections. Wiring connections can be made now.
5. Slide the bollard over on bollard base lined up with the grooves. Be sure to check the LED position on the Bollard.
6. Use the four set screws to secure the bollard to the bollard base.

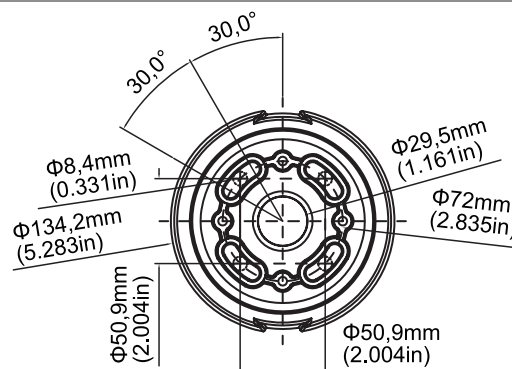

ANCHOR BOLT TEMPLATE FOR BLED BOLLARD

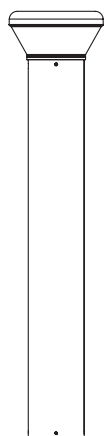

ROUND BOLLARD

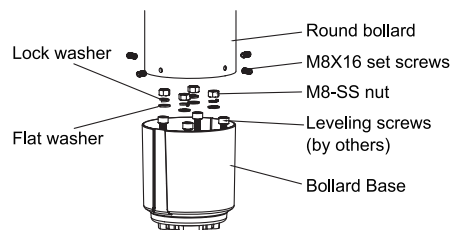
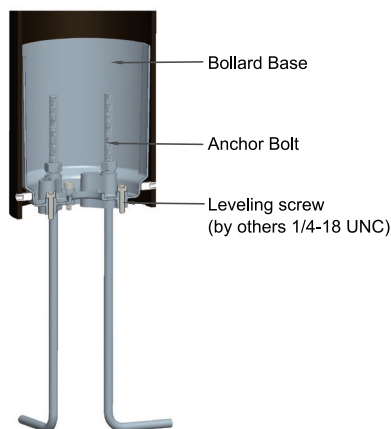

Bollard Luminaire 360 Installation Instructions

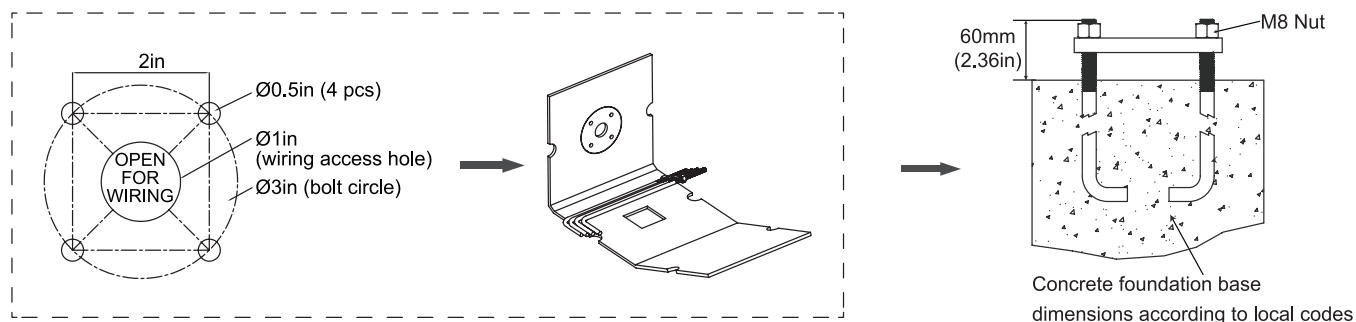

CCT Power Regulator

1. Unscrew the two screws to remove the light pole, make sure the input line during the process, to prevent the pull-apart.

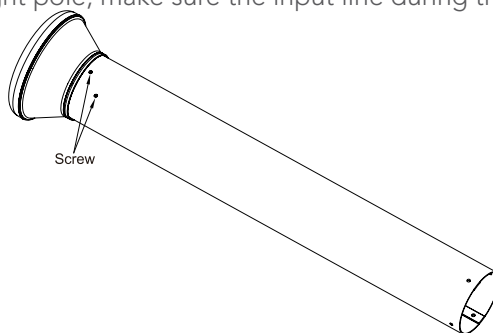

2. Pull the regulator cover out.

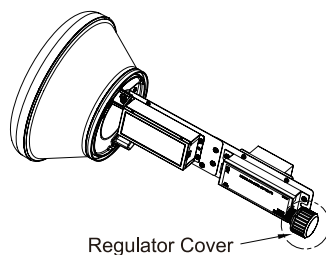

3. Adjust the fixture against the adjustment instructions

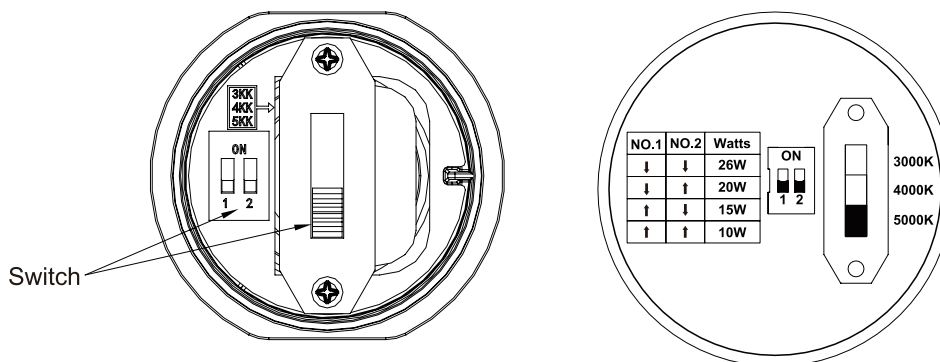





4. Install the accessories after adjustment is complete.
5. To adjust the power, first connect the dimming light to the power adjustment dial.

Bollard Luminaire 360 Installation Instructions



Tools Required

Mounting Type	Accessory	Specifications	Quantity
	Bollard Base	MBL0124DZ-D134H143(D)-YZ	1
	M8-SS nut	M8-SS	4
	Anchor Bolt	MBL0124ZJ-L314W8H67	4
	Flat Washer	M8-DD	4
	Lock Washer	M8-OD15ID8.5H1.4-SS	4

Wire Connection

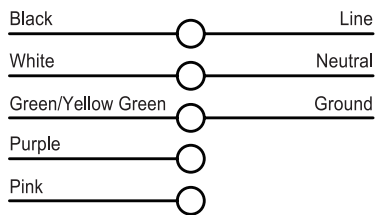

Note: Two dimming wires are in the driver box.

Emergency Wire Connection

