



4" Recessed Integrated Module Downlight



LL-IMODCR4

4" Recessed Integrated Module Downlight

The LITELUME™ LL-IMODCR4 recessed canless integrated module downlight delivers a modern versatile look with aesthetic appeal. Field selectable performance with 5 CCT options ranging from 2700K to 5000K. Available in 4", featuring a Polycarbonate diffuser. with white baffle reflector. Easy installation with its integrated J-box, mounts directly in a hole cut into drywall or ceiling panel, or pair it with our universal new construction mounting plate for use with joist and T-grid ceilings.



PERFORMANCE DATA

Lumen Output	800 lm
Lumens Per Watt (typical)	97 lm/W
CCT - Field Selectable	2700K 3000K 3500K 4000K 5000K
Lifespan	139,000 hrs

RATINGS & CERTIFICATES

Energy Star • FCC • IC Rated • cETLus Wet • Title 24 • JA8 • Interior / Exterior

APPLICATIONS

New Construction • Retrofit & Remodel

FIXTURE INFORMATION

Size	Housing	Finish	Optics	Trim	Beam Angle	Color	
9W	White Aluminum	Premium Powder Coat	Polycarbonate Diffuser	Baffle	100°	White	
Voltage	Dimming		Electrical	PF	THD	CRI	Warranty
120V	Triac Dimming @ 120V		1kV Surge Protection	>.90	<20%	90	10 Year

Operating Temperature: -4°F to 113°F



4" Recessed Integrated Module Downlight

DIMENSIONS

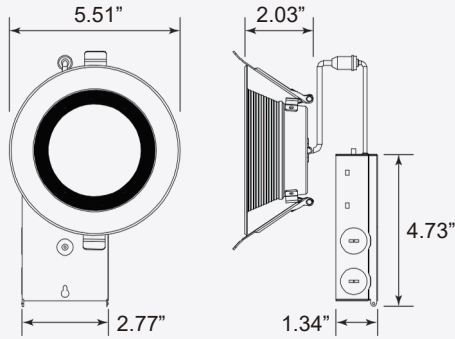

Length (in)	Width (in)	Height (in)	Weight (lbs)
5.51	5.51	2.03	0.64
Junction Box Size (in)		4.73 x 2.77 x 1.34	

LUMEN TABLES

Measurements	Lumens				
	2700K	3000K	3500K	4000K	5000K
Lumens	786	833	876	871	816
Watts	9.56	9.37	8.95	9.16	9.46
Efficacy	82.22	88.90	97.88	95.09	86.26

COMPATIBLE DIMMERS AND CONTROLS

Manufacturer	Model Number		
Lutron	TG-600PR-WH	SLV-600P-AL	DVCL-153P
	S-600PR-WH	DV-600PR-WH	MSCL-OP153M
	CTCL-153PDH-WH	SCL-153PH-WH	PD-6WCL
	TGCL-153PH-LA	GT-600P	MACL-153M//MA-R
Leviton	6672	6674	IPL06
	RNL06	DSL06	-



4" Recessed Integrated Module Downlight

PROJECT NAME	
CATALOG #	
JOB TYPE	
PREPARED BY	
NOTES	

ORDERING GUIDE

Brand	Fixture Type	Lumen Package	CCT
LL LITELUME	IMODCR4 4" Round Recessed Integrated Module	8L 800 Lumens	KFS Kelvin Field Selectable

FIXTURE ORDERING INFORMATION

Part #	Watts	Lumens	Kelvin	Voltage
LL-IMODCR4-8L-KFS	9W	800	5 CCT	120