



Wallpack Large Full Cutoff



*Not all product variations listed on this page are DLC qualified. Visit www.designlights.org/search to confirm qualification



Description

The LITELUME™ Wallpack Large – Full Cutoff (LL-WPLFC) is a Dark Sky compliant LED fixture with a durable polycarbonate optical lens.

Applications: Entryways, Pathway, Perimeter and Security lighting.

Fixture Information

Size:	28W/42W/48W/56W/70W/72W/ 96W/120W
Housing:	Die-cast Aluminum Housing
Finish:	Protective powdercoat
Color:	Standard: Bronze Custom Options: Black (BK) White (WH) Grey (GY)
Mounting:	Standard: Wall Mount
Lens:	Polycarbonate
Voltage:	Standard: 120-277V, 277-480V
Dimmable:	Standard: 0-10v continuous, 12Vdc auxiliary dimming
Controls:	Controls Ready
Power Factor:	.90
CRI:	80
Operating Temperature:	-22°F to 113°F
Sensor:	Standard: (120-277) Photocell & Plug Standard: (277-480V) No Photocell
Warranty:	10-Year Limited Warranty

Performance Data

Lumen Output:

5,211 to 17,148 lm

Lumens Per Watt (typical):

160-170 lm/W

CCT:

3000K
4000K
5000K

Distribution:

Forward Throw

Lifespan:

Up to 100,000 running hours

Ratings & Certificates

UL Listed For Wet Location
Dark Sky Compliant
DLC Premium Listed
Title 24 Compliant





Dimension

Item	Width	Depth	Height	Weight
28W-70W	12.35"	7.94"	7.09"	8.14 lb
48W-120	12.35"	7.94"	7.09"	8.6 lb

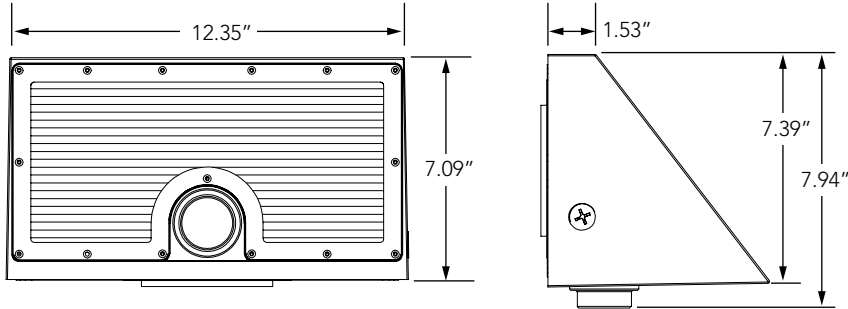

Photometrics

70W, 5000K T4

LUMINOUS INTENSITY DISTRIBUTION DIAGRAM

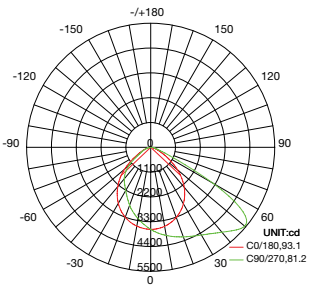

C0 PLANE ISOLUX DIAGRAM (UNIT:lx)

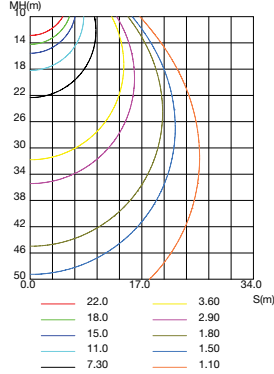

Flux out: 4903 l m

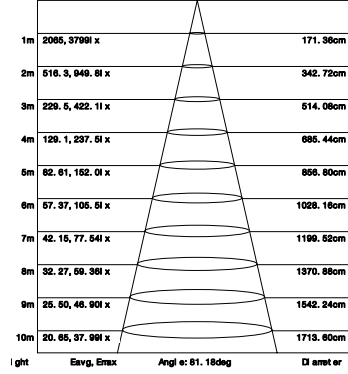

ISOLUX DIAGRAM

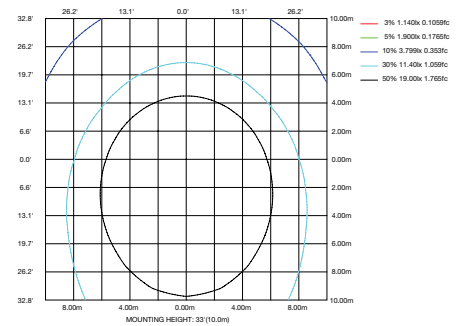

120W, 5000K T4

LUMINOUS INTENSITY DISTRIBUTION DIAGRAM

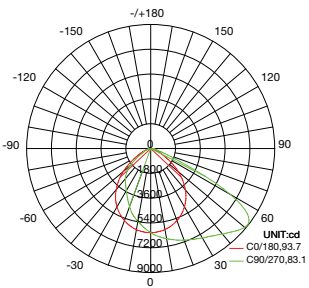

C0 PLANE ISOLUX DIAGRAM (UNIT:lx)

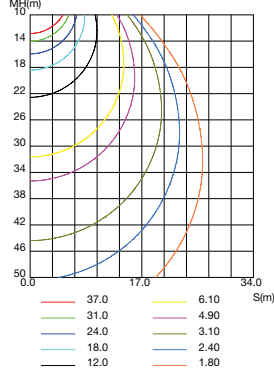

Flux out: 8056 l m

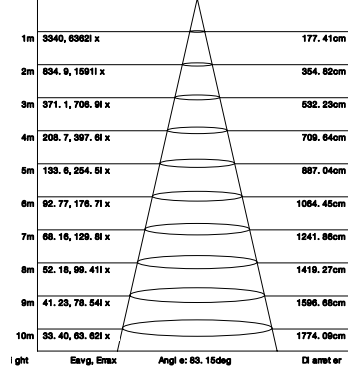

ISOLUX DIAGRAM

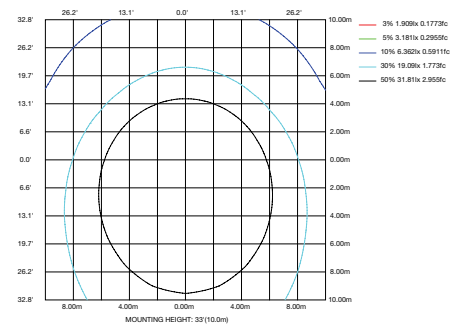



Project Name	
Catalog #	
Job Type	
Prepared By	
Notes	

Fixture Ordering Information

Part #	Wattage	Lumens	Kelvin	Voltage
LL-WPLFC-[28][42][56][70]-3CCT-UNV-BZ-PC	28W/42W/56W/70W	5211/7048/8901/11156	3000K 4000K 5000K	120-277
LL-WPLFC-[48][72][96][120]-2CCT-UNV-BZ-PC	48W/72W/96W/120W	7759/11257/14447/17148	4000K 5000K	120-277
LL-WPLFC-[28][42][56][70]-3CCT-HV-BZ	28W/42W/56W/70W	5211/7048/8901/11156	3000K 4000K 5000K	277-480
LL-WPLFC-[48][72][96][120]-2CCT-HV-BZ	48W/72W/96W/120W	7759/11257/14447/17148	4000K 5000K	277-480

Accessories Ordering Information

Part #	Wattage
ANT-5-4T	Sharkward 12-24V DC 0-10V Plug And Play Microwave Sensor
ANT-6-4T	Sharkward 12-24V DC 0-10V Plug And Play PIR Sensor
ANT-6-4T-BLE-SR	Sharkward Silvair 12-24V DC 0-10V Plug And Play Bluetooth PIR Sensor
ANT-6-4T-BLE-GE	Homewell GEBC 12-24V DC 0-10V Plug And Play Bluetooth PIR Sensor
RC-100	Remote Control 100
AC-EFS106-AUX-W.B1-WH-BL1-2-B	Autani Compatible - Keilton EFS106-AUX-W.B1 Plug And Play Bluetooth Daylight Harvesting And PIR Motion Sensor & WHBL1-2-B Lens LLLC
AC-WPPA102-AUX-W.B1	Autani Compatible - Keilton Plug And Play Bluetooth Long Range Controller Node LLLC
EM8	Emergency Battery Back Up 8W
EM15	Emergency Battery Backup 15W
EMC8	Emergency Battery Back Up Cold Weather 8W -4 °F to 122°F
EMC15	Emergency Battery Back Up Cold Weather 15W -4 °F to 122°F
EMC20	Emergency Battery Back Up Cold Weather 20W -4 °F to 122°F

* Please contact LITELUME for all Custom Option Requests