

# Litelume LED Area Light All Purpose Adjustalume Series



The LITELUME™ Area Light All Purpose (LL-ALAP) Adjustalume Series features an all new one piece extruded aluminum design with outstanding corrosion protection, and secondary UV resistant polycarbonate optics. Compact, low profile, IK08 and 3G vibration rated. The ALAP provides an aesthetically pleasing addition to any application with its steady well defined construction.

## PRODUCT FEATURES

### Fixture Information

Size:	45W/95W/145W
Housing:	Die Cast Aluminum Housing
Finish:	Protective powder coat
Color:	Color: Standard: Bronze Custom Options: Black (BK) White (WH)
Lens:	Polycarbonate
Temperature:	-40°F to +104°F
Voltage:	Standard: 120-277V Optional: 277-480V
CRI:	70
Power Factor:	>.95
Sensor:	Standard: No sensor Optional: Microwave motion sensor, Twist Lock Photocell and Receptacle
Warranty:	5-Year Limited Warranty

### Performance Data

#### Lumen Output:

6,300 to 20,300 lm

#### Lumens Per Watt (typical):

140 lm/W

#### CCT:

3000K

4000K

5000K

#### Distribution:

Type III

#### Lifespan:

Features 3030 LED's with up to 100,000 running hours

#### Ratings & Certificates

cUL Listed for Wet Location

IP65

IK08

DLC Premium listed

### QuickShip Ordering Information

<b>Part #</b>
LL-ALAP-[45][95][145]-3CCT-UNV-T3-BZ
PMAR
SF
SMA

# Litelume LED Area Light All Purpose Adjustalume Series



## Dimension

Item	Height	Width	Length
45W/95W/145W	13.53"	2.28"	12.87"

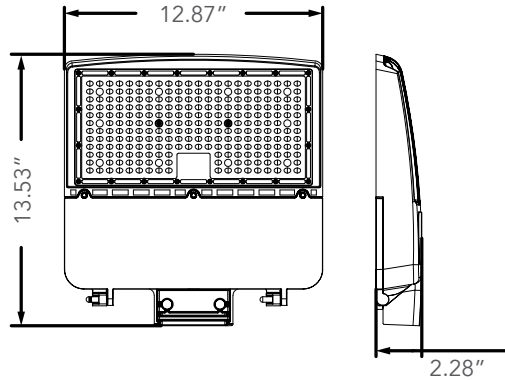

## Mounting Options

SF-Slipfitter		SF on Pole

# Litelume LED Area Light All Purpose Adjustalume Series



PMAR- Pole Mount Adjustable with Round Adapter		PMAR on Pole

SMA- Surface Mount Adjustable		

# Litelume LED Area Light All Purpose Adjustalume Series



<b>Project Name</b>	
<b>Catalog #</b>	
<b>Job Type</b>	
<b>Prepared By</b>	
<b>Notes</b>	

## Fixture Ordering Information

Part #	Wattage	Lumens	CCT	Voltage	Distribution	Finish
LL-ALAP-45-3CCT-UNV-T3-BZ	45	6300	3000K/4000K/5000K SELECTABLE	120-277V	Type III	Bronze
LL-ALAP-95-3CCT-UNV-T3-BZ	95	13300	3000K/4000K/5000K SELECTABLE	120-277V	Type III	Bronze
LL-ALAP-145-3CCT-UNV-T3-BZ	145	20300	3000K/4000K/5000K SELECTABLE	120-277V	Type III	Bronze
LL-ALAP-45-3CCT-HV-T3-BZ	45	6300	3000K/4000K/5000K SELECTABLE	277-480V	Type III	Bronze
LL-ALAP-95-3CCT-HV-T3-BZ	95	13300	3000K/4000K/5000K SELECTABLE	277-480V	Type III	Bronze
LL-ALAP-145-3CCT-HV-T3-BZ	145	20300	3000K/4000K/5000K SELECTABLE	277-480V	Type III	Bronze

## Quick Ship Ordering Information

<b>Part #</b>
LL-ALAP-[45][95][145]-3CCT-UNV-T3-BZ
PMAR
SF
SMA

## Mounting Ordering Information

Part #	Description
SF	Slipfitter
SMA	Surface Mount Adjustable
PMAR	Pole Mount Adjustable with Round Adapter

\* Please contact LITELUME for all Custom Option Requests

## Accessories Ordering Information

Part #	Description
MMS	Microwave Motion Sensor
TLPC	Twist Lock Photocell

\* Please contact LITELUME for all Custom Option Requests